

Collection Ersa



Collection Ersa

Chandelier



Collection Images page 66-67, 70-73

Art.nr.	Dimensions	Light bulb	Weight	Finish
ERSA4BLM-GLIRI	L.80xW.55xH.50 cm	4x E27	11,0 kg	black matt finish, glass sphere iridescent
ERSA4N-GLIRI	L.80xW.55xH.50 cm	4x E27	11,0 kg	nickel finish, glass sphere iridescent
ERSA4BR-GLIRI	L.80xW.55xH.50 cm	4x E27	11,0 kg	brass finish, glass sphere iridescent
ERSA4BRBUR-GLIRI	L.80xW.55xH.50 cm	4x E27	11,0 kg	brass burnished finish, glass sphere iridescent
ERSA4NAW-GLIRI	L.80xW.55xH.50 cm	4x E27	11,0 kg	nickel aged warm finish, glass sphere iridescent
ERSA4GSF-GLIRI	L.80xW.55xH.50 cm	4x E27	11,0 kg	gold satin finish, glass sphere iridescent
ERSAC80BLM-GLIRI	Ø80xH.55 cm	5x E27	15,0 kg	black matt finish, glass sphere iridescent
ERSAC80N-GLIRI	Ø80xH.55 cm	5x E27	15,0 kg	nickel finish, glass sphere iridescent
ERSAC80BR-GLIRI	Ø80xH.55 cm	5x E27	15,0 kg	brass finish, glass sphere iridescent
ERSAC80BRBUR-GLIRI	Ø80xH.55 cm	5x E27	15,0 kg	brass burnished finish, glass sphere iridescent
ERSAC80NAW-GLIRI	Ø80xH.55 cm	5x E27	15,0 kg	nickel aged warm finish, glass sphere iridescent
ERSAC80GSF-GLIRI	Ø80xH.55 cm	5x E27	15,0 kg	gold satin finish, glass sphere iridescent
ERSAC100BLM-GLIRI	Ø110xH.65 cm	7x E27	23,0 kg	black matt finish, glass sphere iridescent
ERSAC100N-GLIRI	Ø110xH.65 cm	7x E27	23,0 kg	nickel finish, glass sphere iridescent
ERSAC100BR-GLIRI	Ø110xH.65 cm	7x E27	23,0 kg	brass finish, glass sphere iridescent
ERSAC100BRBUR-GLIRI	Ø110xH.65 cm	7x E27	23,0 kg	brass burnished finish, glass sphere iridescent
ERSAC100NAW-GLIRI	Ø110xH.65 cm	7x E27	23,0 kg	nickel aged warm finish, glass sphere iridescent
ERSAC100GSF-GLIRI	Ø110xH.65 cm	7x E27	23,0 kg	gold satin finish, glass sphere iridescent

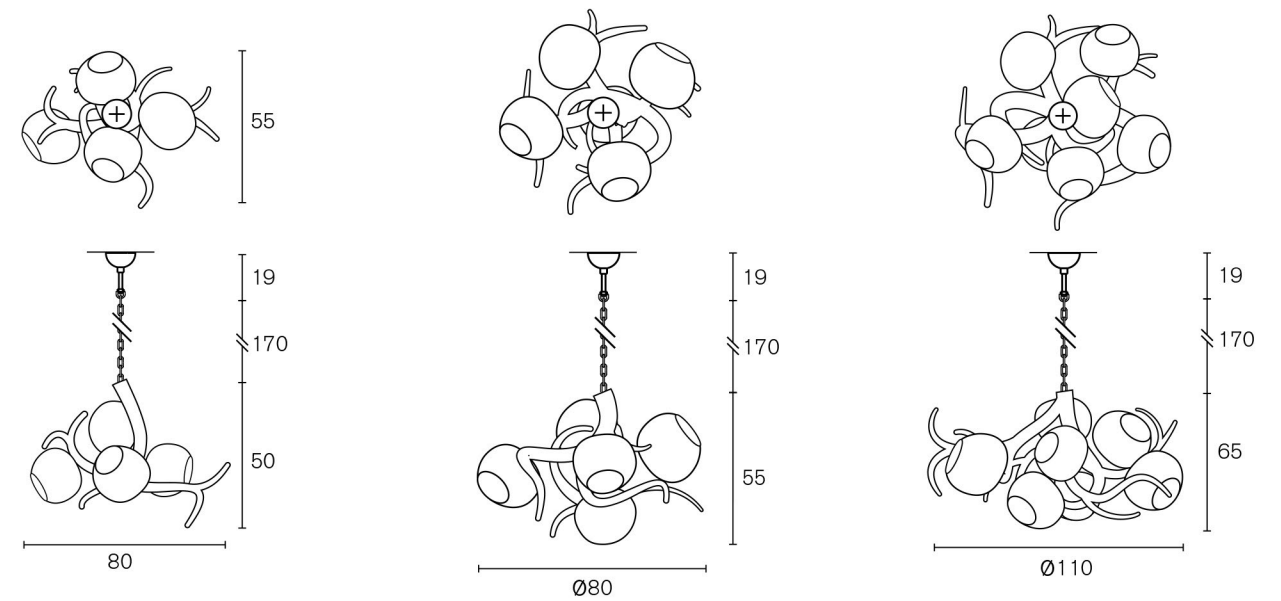

ERSAC120N-GLIRI

Ersa Chandelier Round with iridescent glass spheres (Ø120xH.65 cm, nickel finish, 10x E27, 32,0 kg)

Specifications are subject to change without prior notice.

Catalogue Edition 31

Standard the ERSA will be delivered with iridescent glass spheres. Other options are bronze translucent or clear glass spheres. All chandeliers are supplied with 1,7 meter chain, 2 meter electrical cable and a ceiling shade.

Specifications are subject to change without prior notice.

Catalogue Edition 31

Collection Ersa

Chandelier



Collection Images page 68-69

Art.nr.	Dimensions	Light bulb	Weight	Finish
ERSAC120BLM-GLIRI	Ø120xH.65 cm	10x E27	32,0 kg	black matt finish, glass sphere iridescent
ERSAC120N-GLIRI	Ø120xH.65 cm	10x E27	32,0 kg	nickel finish, glass sphere iridescent
ERSAC120BR-GLIRI	Ø120xH.65 cm	10x E27	32,0 kg	brass finish, glass sphere iridescent
ERSAC120BRBUR-GLIRI	Ø120xH.65 cm	10x E27	32,0 kg	brass burnished finish, glass sphere iridescent
ERSAC120NAW-GLIRI	Ø120xH.65 cm	10x E27	32,0 kg	nickel aged warm finish, glass sphere iridescent
ERSAC120GSF-GLIRI	Ø120xH.65 cm	10x E27	32,0 kg	gold satin finish, glass sphere iridescent
ERSAC140BLM-GLIRI	Ø140xH.70 cm	13x E27	40,0 kg	black matt finish, glass sphere iridescent
ERSAC140N-GLIRI	Ø140xH.70 cm	13x E27	40,0 kg	nickel finish, glass sphere iridescent
ERSAC140BR-GLIRI	Ø140xH.70 cm	13x E27	40,0 kg	brass finish, glass sphere iridescent
ERSAC140BRBUR-GLIRI	Ø140xH.70 cm	13x E27	40,0 kg	brass burnished finish, glass sphere iridescent
ERSAC140NAW-GLIRI	Ø140xH.70 cm	13x E27	40,0 kg	nickel aged warm finish, glass sphere iridescent
ERSAC140GSF-GLIRI	Ø140xH.70 cm	13x E27	40,0 kg	gold satin finish, glass sphere iridescent

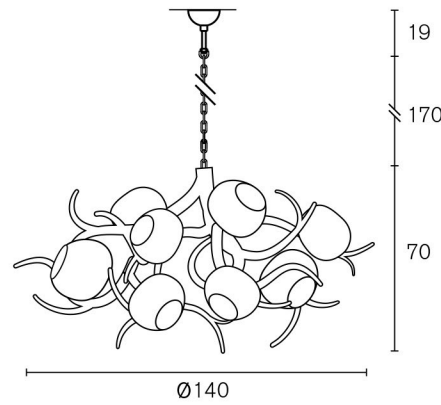
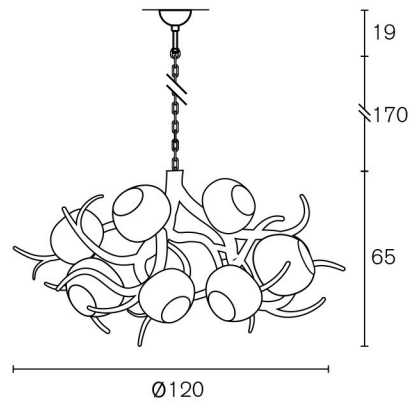
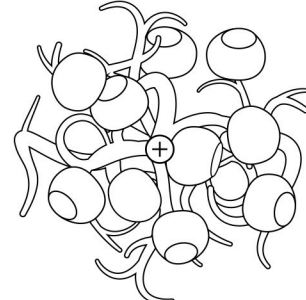
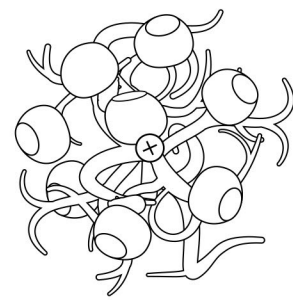

Standard the ERSA will be delivered with iridescent glass spheres. Other options are bronze translucent or clear glass spheres.
All chandeliers are supplied with 1,7 meter chain, 2 meter electrical cable and a ceiling shade.

Specifications are subject to change without prior notice.

Collection Ersa

Chandelier Conical



Collection Images page 74-75

Art.nr.	Dimensions	Light bulb	Weight	Finish
ERSACC90BLM-GLIRI	Ø90xH.120 cm	9x E27	35,0 kg	black matt finish, glass sphere iridescent
ERSACC90N-GLIRI	Ø90xH.120 cm	9x E27	35,0 kg	nickel finish, glass sphere iridescent
ERSACC90BR-GLIRI	Ø90xH.120 cm	9x E27	35,0 kg	brass finish, glass sphere iridescent
ERSACC90BRBUR-GLIRI	Ø90xH.120 cm	9x E27	35,0 kg	brass burnished finish, glass sphere iridescent
ERSACC90NAW-GLIRI	Ø90xH.120 cm	9x E27	35,0 kg	nickel aged warm finish, glass sphere iridescent
ERSACC90GSF-GLIRI	Ø90xH.120 cm	9x E27	35,0 kg	gold satin finish, glass sphere iridescent
ERSACC110BLM-GLIRI	Ø110xH.130 cm	12x E27	45,0 kg	black matt finish, glass sphere iridescent
ERSACC110N-GLIRI	Ø110xH.130 cm	12x E27	45,0 kg	nickel finish, glass sphere iridescent
ERSACC110BR-GLIRI	Ø110xH.130 cm	12x E27	45,0 kg	brass finish, glass sphere iridescent
ERSACC110BRBUR-GLIRI	Ø110xH.130 cm	12x E27	45,0 kg	brass burnished finish, glass sphere iridescent
ERSACC110NAW-GLIRI	Ø110xH.130 cm	12x E27	45,0 kg	nickel aged warm finish, glass sphere iridescent
ERSACC110GSF-GLIRI	Ø110xH.130 cm	12x E27	45,0 kg	gold satin finish, glass sphere iridescent
ERSACC130BLM-GLIRI	Ø120xH.140 cm	16x E27	55,0 kg	black matt finish, glass sphere iridescent
ERSACC130N-GLIRI	Ø120xH.140 cm	16x E27	55,0 kg	nickel finish, glass sphere iridescent
ERSACC130BR-GLIRI	Ø120xH.140 cm	16x E27	55,0 kg	brass finish, glass sphere iridescent
ERSACC130BRBUR-GLIRI	Ø120xH.140 cm	16x E27	55,0 kg	brass burnished finish, glass sphere iridescent
ERSACC130NAW-GLIRI	Ø120xH.140 cm	16x E27	55,0 kg	nickel aged warm finish, glass sphere iridescent
ERSACC130GSF-GLIRI	Ø120xH.140 cm	16x E27	55,0 kg	gold satin finish, glass sphere iridescent

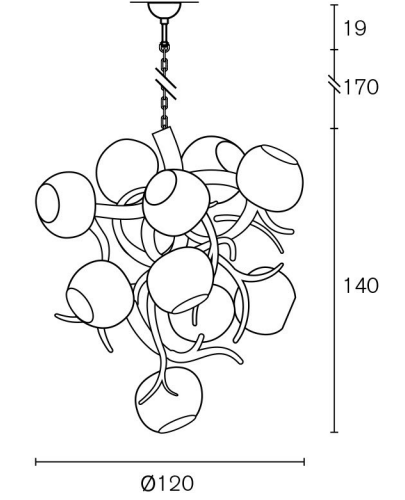
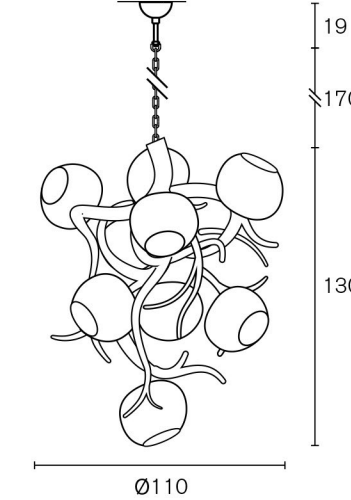
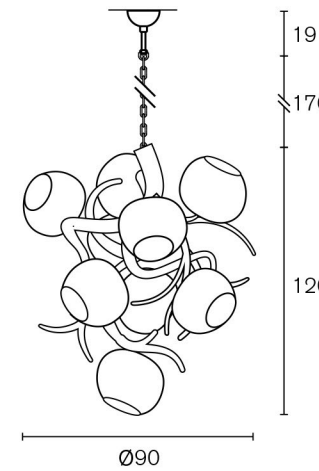
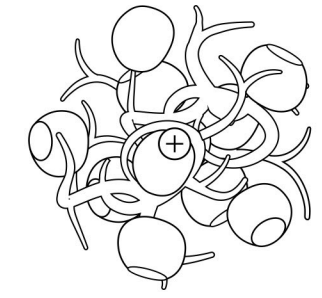
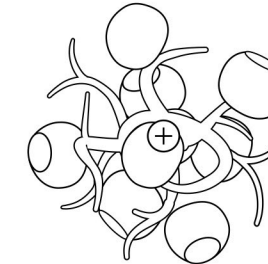
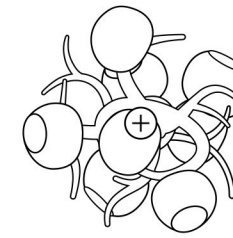

Standard the ERSA will be delivered with iridescent glass spheres. Other options are bronze translucent or clear glass spheres.
All chandeliers are supplied with 1,7 meter chain, 2 meter electrical cable and a ceiling shade.

Specifications are subject to change without prior notice.

Collection Ersa

Chandelier Oval



Collection Images page 76-79

Art.nr.	Dimensions	Light bulb	Weight	Finish
ERSAOC120BLM-GLIRI	L.120xW.60xH.55 cm	5x E27	19,0 kg	black matt finish, glass sphere iridescent
ERSAOC120N-GLIRI	L.120xW.60xH.55 cm	5x E27	19,0 kg	nickel finish, glass sphere iridescent
ERSAOC120BR-GLIRI	L.120xW.60xH.55 cm	5x E27	19,0 kg	brass finish, glass sphere iridescent
ERSAOC120BRBUR-GLIRI	L.120xW.60xH.55 cm	5x E27	19,0 kg	brass burnished finish, glass sphere iridescent
ERSAOC120NAW-GLIRI	L.120xW.60xH.55 cm	5x E27	19,0 kg	nickel aged warm finish, glass sphere iridescent
ERSAOC120GSF-GLIRI	L.120xW.60xH.55 cm	5x E27	19,0 kg	gold satin finish, glass sphere iridescent
ERSAOC140BLM-GLIRI	L.140xW.60xH.55 cm	7x E27	22,0 kg	black matt finish, glass sphere iridescent
ERSAOC140N-GLIRI	L.140xW.60xH.55 cm	7x E27	22,0 kg	nickel finish, glass sphere iridescent
ERSAOC140BR-GLIRI	L.140xW.60xH.55 cm	7x E27	22,0 kg	brass finish, glass sphere iridescent
ERSAOC140BRBUR-GLIRI	L.140xW.60xH.55 cm	7x E27	22,0 kg	brass burnished finish, glass sphere iridescent
ERSAOC140NAW-GLIRI	L.140xW.60xH.55 cm	7x E27	22,0 kg	nickel aged warm finish, glass sphere iridescent
ERSAOC140GSF-GLIRI	L.140xW.60xH.55 cm	7x E27	22,0 kg	gold satin finish, glass sphere iridescent
ERSAOC160BLM-GLIRI	L.160xW.60xH.55 cm	8x E27	24,0 kg	black matt finish, glass sphere iridescent
ERSAOC160N-GLIRI	L.160xW.60xH.55 cm	8x E27	24,0 kg	nickel finish, glass sphere iridescent
ERSAOC160BR-GLIRI	L.160xW.60xH.55 cm	8x E27	24,0 kg	brass finish, glass sphere iridescent
ERSAOC160BRBUR-GLIRI	L.160xW.60xH.55 cm	8x E27	24,0 kg	brass burnished finish, glass sphere iridescent
ERSAOC160NAW-GLIRI	L.160xW.60xH.55 cm	8x E27	24,0 kg	nickel aged warm finish, glass sphere iridescent
ERSAOC160GSF-GLIRI	L.160xW.60xH.55 cm	8x E27	24,0 kg	gold satin finish, glass sphere iridescent
ERSAOC180BLM-GLIRI	L.180xW.60xH.55 cm	9x E27	27,0 kg	black matt finish, glass sphere iridescent
ERSAOC180N-GLIRI	L.180xW.60xH.55 cm	9x E27	27,0 kg	nickel finish, glass sphere iridescent
ERSAOC180BR-GLIRI	L.180xW.60xH.55 cm	9x E27	27,0 kg	brass finish, glass sphere iridescent
ERSAOC180BRBUR-GLIRI	L.180xW.60xH.55 cm	9x E27	27,0 kg	brass burnished finish, glass sphere iridescent
ERSAOC180NAW-GLIRI	L.180xW.60xH.55 cm	9x E27	27,0 kg	nickel aged warm finish, glass sphere iridescent
ERSAOC180GSF-GLIRI	L.180xW.60xH.55 cm	9x E27	27,0 kg	gold satin finish, glass sphere iridescent

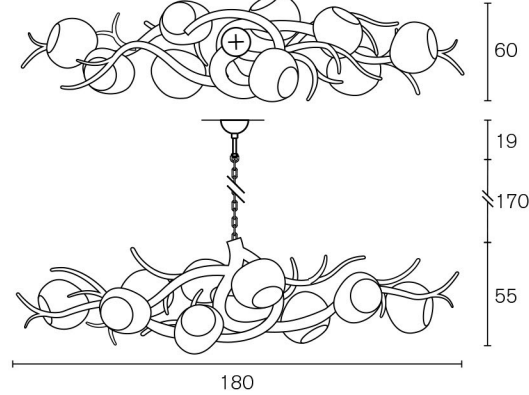
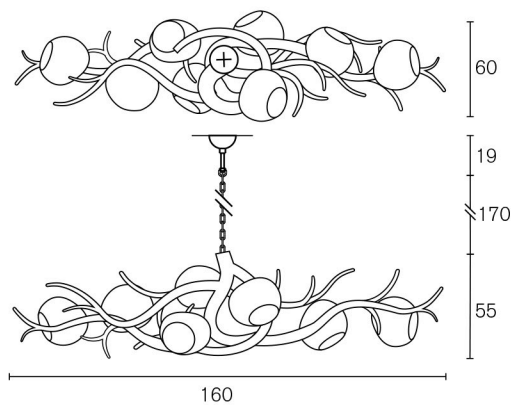
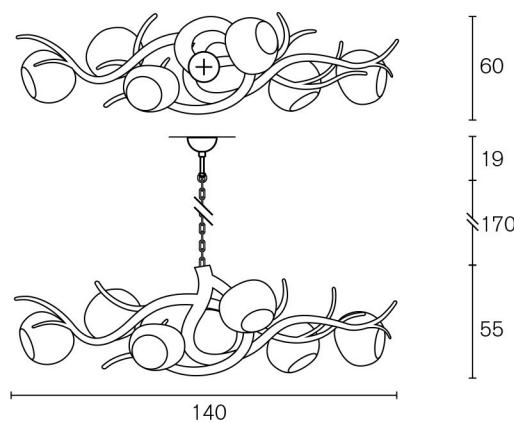
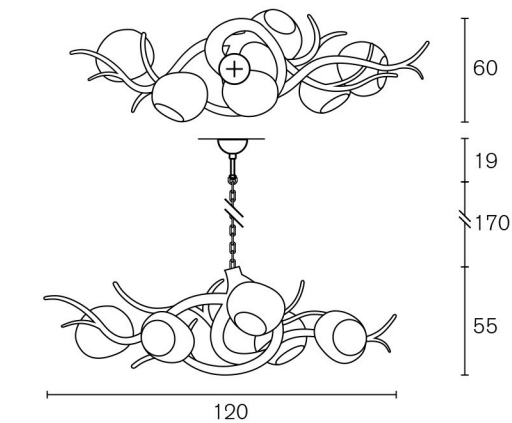

Standard the ERSA will be delivered with iridescent glass spheres. Other options are bronze translucent or clear glass spheres. All chandeliers are supplied with 1,7 meter chain, 2 meter electrical cable and a ceiling shade.

Specifications are subject to change without prior notice.

Collection Ersa

Suspension Vertical



Collection Images page 80-83

Art.nr.	Dimensions	Light bulb	Weight	Finish
ERSAV110BLM-GLIRI	Ø60xH.110 cm	5x E27	16,0 kg	black matt finish, glass sphere iridescent
ERSAV110N-GLIRI	Ø60xH.110 cm	5x E27	16,0 kg	nickel finish, glass sphere iridescent
ERSAV110BR-GLIRI	Ø60xH.110 cm	5x E27	16,0 kg	brass finish, glass sphere iridescent
ERSAV110BRBUR-GLIRI	Ø60xH.110 cm	5x E27	16,0 kg	brass burnished finish, glass sphere iridescent
ERSAV110NAW-GLIRI	Ø60xH.110 cm	5x E27	16,0 kg	nickel aged warm finish, glass sphere iridescent
ERSAV110GSF-GLIRI	Ø60xH.110 cm	5x E27	16,0 kg	gold satin finish, glass sphere iridescent
ERSAV130BLM-GLIRI	Ø90xH.130 cm	8x E27	27,0 kg	black matt finish, glass sphere iridescent
ERSAV130N-GLIRI	Ø90xH.130 cm	8x E27	27,0 kg	nickel finish, glass sphere iridescent
ERSAV130BR-GLIRI	Ø90xH.130 cm	8x E27	27,0 kg	brass finish, glass sphere iridescent
ERSAV130BRBUR-GLIRI	Ø90xH.130 cm	8x E27	27,0 kg	brass burnished finish, glass sphere iridescent
ERSAV130NAW-GLIRI	Ø90xH.130 cm	8x E27	27,0 kg	nickel aged warm finish, glass sphere iridescent
ERSAV130GSF-GLIRI	Ø90xH.130 cm	8x E27	27,0 kg	gold satin finish, glass sphere iridescent
ERSAV160BLM-GLIRI	Ø90xH.160 cm	9x E27	35,0 kg	black matt finish, glass sphere iridescent
ERSAV160N-GLIRI	Ø90xH.160 cm	9x E27	35,0 kg	nickel finish, glass sphere iridescent
ERSAV160BR-GLIRI	Ø90xH.160 cm	9x E27	35,0 kg	brass finish, glass sphere iridescent
ERSAV160BRBUR-GLIRI	Ø90xH.160 cm	9x E27	35,0 kg	brass burnished finish, glass sphere iridescent
ERSAV160NAW-GLIRI	Ø90xH.160 cm	9x E27	35,0 kg	nickel aged warm finish, glass sphere iridescent
ERSAV160GSF-GLIRI	Ø90xH.160 cm	9x E27	35,0 kg	gold satin finish, glass sphere iridescent
ERSAV180BLM-GLIRI	Ø90xH.180 cm	9x E27	42,0 kg	black matt finish, glass sphere iridescent
ERSAV180N-GLIRI	Ø90xH.180 cm	9x E27	42,0 kg	nickel finish, glass sphere iridescent
ERSAV180BR-GLIRI	Ø90xH.180 cm	9x E27	42,0 kg	brass finish, glass sphere iridescent
ERSAV180BRBUR-GLIRI	Ø90xH.180 cm	9x E27	42,0 kg	brass burnished finish, glass sphere iridescent
ERSAV180NAW-GLIRI	Ø90xH.180 cm	9x E27	42,0 kg	nickel aged warm finish, glass sphere iridescent
ERSAV180GSF-GLIRI	Ø90xH.180 cm	9x E27	42,0 kg	gold satin finish, glass sphere iridescent

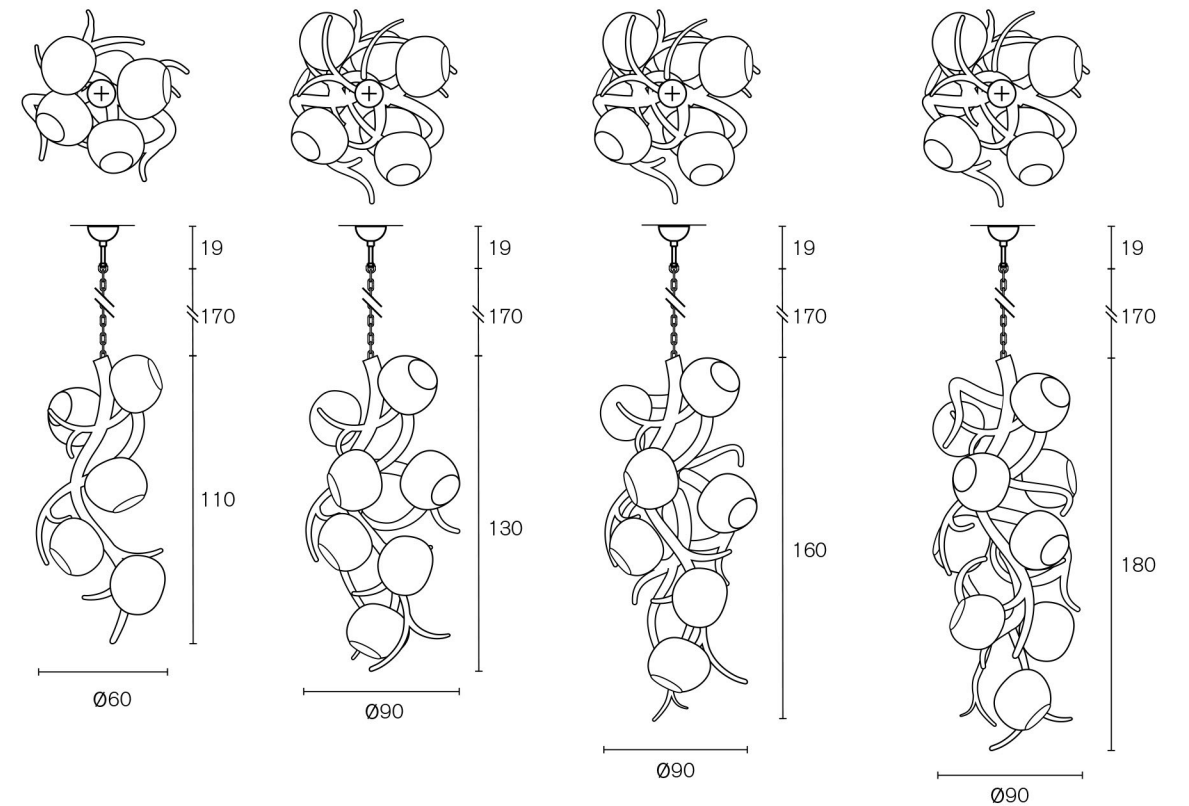

Standard the ERSA will be delivered with iridescent glass spheres. Other options are bronze translucent or clear glass spheres. All chandeliers are supplied with 1,7 meter chain, 2 meter electrical cable and a ceiling shade.

Specifications are subject to change without prior notice.

Collection Ersa



Hanging Lamp Long

Collection Images page 85-89, 317

Art.nr.	Dimensions	Light bulb	Weight	Finish
ERSAHL125BLM-GLIRI	L.125xW.45xH.35 cm	5x E27	13,0 kg	black matt finish, glass sphere iridescent
ERSAHL125N-GLIRI	L.125xW.45xH.35 cm	5x E27	13,0 kg	nickel finish, glass sphere iridescent
ERSAHL125BR-GLIRI	L.125xW.45xH.35 cm	5x E27	13,0 kg	brass finish, glass sphere iridescent
ERSAHL125BRBUR-GLIRI	L.125xW.45xH.35 cm	5x E27	13,0 kg	brass burnished finish, glass sphere iridescent
ERSAHL125NAW-GLIRI	L.125xW.45xH.35 cm	5x E27	13,0 kg	nickel aged warm finish, glass sphere iridescent
ERSAHL125GSF-GLIRI	L.125xW.45xH.35 cm	5x E27	13,0 kg	gold satin finish, glass sphere iridescent
ERSAHL150BLM-GLIRI	L.150xW.45xH.35 cm	5x E27	15,0 kg	black matt finish, glass sphere iridescent
ERSAHL150N-GLIRI	L.150xW.45xH.35 cm	5x E27	15,0 kg	nickel finish, glass sphere iridescent
ERSAHL150BR-GLIRI	L.150xW.45xH.35 cm	5x E27	15,0 kg	brass finish, glass sphere iridescent
ERSAHL150BRBUR-GLIRI	L.150xW.45xH.35 cm	5x E27	15,0 kg	brass burnished finish, glass sphere iridescent
ERSAHL150NAW-GLIRI	L.150xW.45xH.35 cm	5x E27	15,0 kg	nickel aged warm finish, glass sphere iridescent
ERSAHL150GSF-GLIRI	L.150xW.45xH.35 cm	5x E27	15,0 kg	gold satin finish, glass sphere iridescent
ERSAHL175BLM-GLIRI	L.175xW.45xH.35 cm	6x E27	18,0 kg	black matt finish, glass sphere iridescent
ERSAHL175N-GLIRI	L.175xW.45xH.35 cm	6x E27	18,0 kg	nickel finish, glass sphere iridescent
ERSAHL175BR-GLIRI	L.175xW.45xH.35 cm	6x E27	18,0 kg	brass finish, glass sphere iridescent
ERSAHL175BRBUR-GLIRI	L.175xW.45xH.35 cm	6x E27	18,0 kg	brass burnished finish, glass sphere iridescent
ERSAHL175NAW-GLIRI	L.175xW.45xH.35 cm	6x E27	18,0 kg	nickel aged warm finish, glass sphere iridescent
ERSAHL175GSF-GLIRI	L.175xW.45xH.35 cm	6x E27	18,0 kg	gold satin finish, glass sphere iridescent

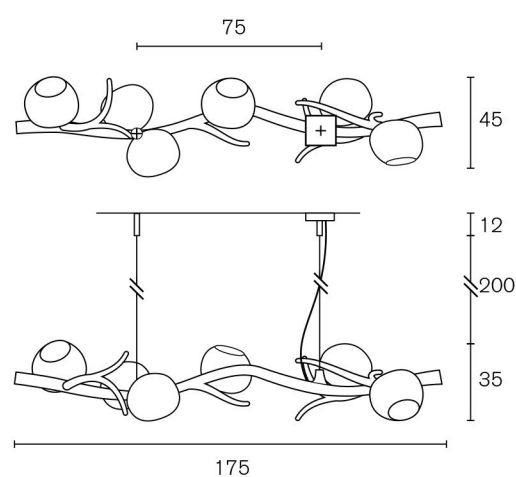
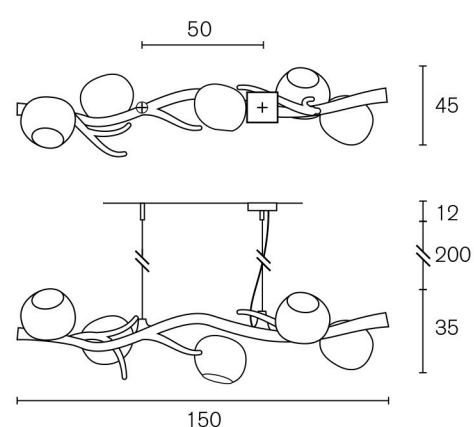
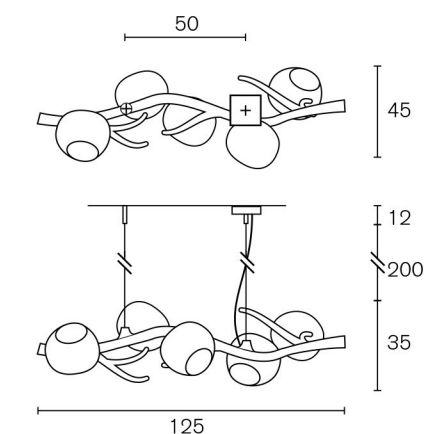

Standard the ERSA will be delivered with iridescent glass spheres. Other options are bronze translucent or clear glass spheres. All hanging lamps long are supplied with 2 meter steel cable, 2 meter electrical cable and a ceiling shade.

Specifications are subject to change without prior notice.

Collection Ersa



Hanging Lamp Long

Collection Images page 83-89

Art.nr.	Dimensions	Light bulb	Weight	Finish
ERSAHL200BLM-GLIRI	L.200xW.45xH.35 cm	7x E27	22,0 kg	black matt finish, glass sphere iridescent
ERSAHL200N-GLIRI	L.200xW.45xH.35 cm	7x E27	22,0 kg	nickel finish, glass sphere iridescent
ERSAHL200BR-GLIRI	L.200xW.45xH.35 cm	7x E27	22,0 kg	brass finish, glass sphere iridescent
ERSAHL200BRBUR-GLIRI	L.200xW.45xH.35 cm	7x E27	22,0 kg	brass burnished finish, glass sphere iridescent
ERSAHL200NAW-GLIRI	L.200xW.45xH.35 cm	7x E27	22,0 kg	nickel aged warm finish, glass sphere iridescent
ERSAHL200GSF-GLIRI	L.200xW.45xH.35 cm	7x E27	22,0 kg	gold satin finish, glass sphere iridescent
ERSAHL225BLM-GLIRI	L.225xW.45xH.35 cm	8x E27	25,0 kg	black matt finish, glass sphere iridescent
ERSAHL225N-GLIRI	L.225xW.45xH.35 cm	8x E27	25,0 kg	nickel finish, glass sphere iridescent
ERSAHL225BR-GLIRI	L.225xW.45xH.35 cm	8x E27	25,0 kg	brass finish, glass sphere iridescent
ERSAHL225BRBUR-GLIRI	L.225xW.45xH.35 cm	8x E27	25,0 kg	brass burnished finish, glass sphere iridescent
ERSAHL225NAW-GLIRI	L.225xW.45xH.35 cm	8x E27	25,0 kg	nickel aged warm finish, glass sphere iridescent
ERSAHL225GSF-GLIRI	L.225xW.45xH.35 cm	8x E27	25,0 kg	gold satin finish, glass sphere iridescent

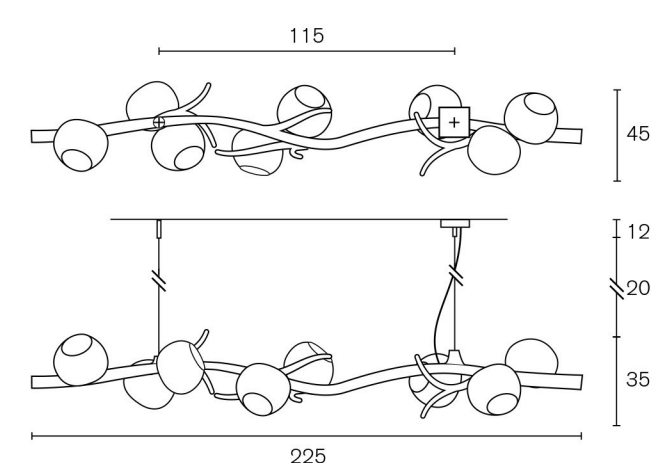
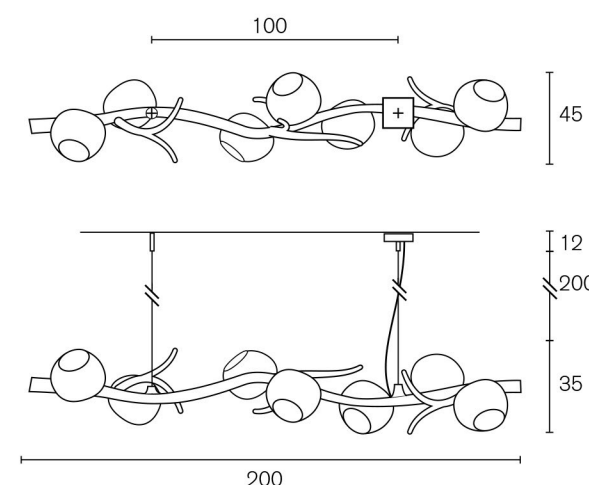

Ceiling Lamp Round

Collection Images page 96

Art.nr.	Dimensions	Light bulb	Weight	Finish
ERSAP60BLM-GLIRI	Ø60xH.25 cm	3x E27	10,0 kg	black matt finish, glass sphere iridescent
ERSAP60N-GLIRI	Ø60xH.25 cm	3x E27	10,0 kg	nickel finish, glass sphere iridescent
ERSAP60BR-GLIRI	Ø60xH.25 cm	3x E27	10,0 kg	brass finish, glass sphere iridescent
ERSAP60BRBUR-GLIRI	Ø60xH.25 cm	3x E27	10,0 kg	brass burnished finish, glass sphere iridescent
ERSAP60NAW-GLIRI	Ø60xH.25 cm	3x E27	10,0 kg	nickel aged warm finish, glass sphere iridescent
ERSAP60GSF-GLIRI	Ø60xH.25 cm	3x E27	10,0 kg	gold satin finish, glass sphere iridescent

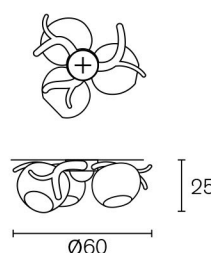

Standard the ERSA will be delivered with iridescent glass spheres. Other options are bronze translucent or clear glass spheres. All hanging lamps long are supplied with 2 meter steel cable, 2 meter electrical cable and a ceiling shade.

Specifications are subject to change without prior notice.

Collection Ersa



Ceiling Chandelier

Collection Images page 94-95

Art.nr.	Dimensions	Light bulb	Weight	Finish
ERSACP80BLM-GLIRI	Ø80xH.60 cm	5x E27	13,0 kg	black matt finish, glass sphere iridescent
ERSACP80N-GLIRI	Ø80xH.60 cm	5x E27	13,0 kg	nickel finish, glass sphere iridescent
ERSACP80BR-GLIRI	Ø80xH.60 cm	5x E27	13,0 kg	brass finish, glass sphere iridescent
ERSACP80BRBUR-GLIRI	Ø80xH.60 cm	5x E27	13,0 kg	brass burnished finish, glass sphere iridescent
ERSACP80NAW-GLIRI	Ø80xH.60 cm	5x E27	13,0 kg	nickel aged warm finish, glass sphere iridescent
ERSACP80GSF-GLIRI	Ø80xH.60 cm	5x E27	13,0 kg	gold satin finish, glass sphere iridescent

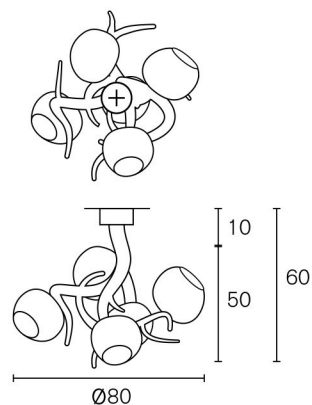

Floor lamp

Collection Images page 98-99

Art.nr.	Dimensions	Light bulb	Weight	Finish
ERSAF200BLM-GLIRI	Ø40xH.205 cm	3x E27	24,0 kg	black matt finish, glass sphere iridescent
ERSAF200N-GLIRI	Ø40xH.205 cm	3x E27	24,0 kg	nickel finish, glass sphere iridescent
ERSAF200BR-GLIRI	Ø40xH.205 cm	3x E27	24,0 kg	brass finish, glass sphere iridescent
ERSAF200BRBUR-GLIRI	Ø40xH.205 cm	3x E27	24,0 kg	brass burnished finish, glass sphere iridescent
ERSAF200NAW-GLIRI	Ø40xH.205 cm	3x E27	24,0 kg	nickel aged warm finish, glass sphere iridescent
ERSAF200GSF-GLIRI	Ø40xH.205 cm	3x E27	24,0 kg	gold satin finish, glass sphere iridescent

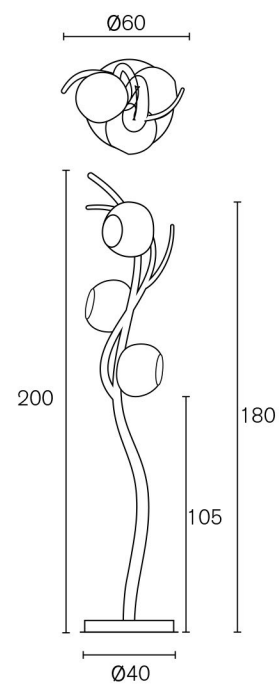

Standard the ERSA will be delivered with iridescent glass spheres. Other options are bronze translucent or clear glass spheres.
All floor lamps are supplied with a floor dimmer. Floor lamps will be applied with a protective nano wax if ordered in brass burnished or copper burnished finish.

Specifications are subject to change without prior notice.

Collection Ersa



Wall lamp

Collection Images page 97

Art.nr.	Dimensions	Light bulb	Weight	Finish
ERSAW30BLM-GLIRI-L	W.30xH.45xD.29 cm	1x E27	4,0 kg	black matt finish, glass sphere iridescent, left version
ERSAW30BLM-GLIRI-R	W.30xH.45xD.29 cm	1x E27	4,0 kg	black matt finish, glass sphere iridescent, right version
ERSAW30N-GLIRI-L	W.30xH.45xD.29 cm	1x E27	4,0 kg	nickel finish, glass sphere iridescent, right version
ERSAW30N-GLIRI-R	W.30xH.45xD.29 cm	1x E27	4,0 kg	nickel finish, glass sphere iridescent, left version
ERSAW30BR-GLIRI-L	W.30xH.45xD.29 cm	1x E27	4,0 kg	brass finish, glass sphere iridescent, left version
ERSAW30BR-GLIRI-R	W.30xH.45xD.29 cm	1x E27	4,0 kg	brass finish, glass sphere iridescent, right version
ERSAW30BRBUR-GLIRI-L	W.30xH.45xD.29 cm	1x E27	4,0 kg	brass burnished finish, glass sphere iridescent, left version
ERSAW30BRBUR-GLIRI-R	W.30xH.45xD.29 cm	1x E27	4,0 kg	brass burnished finish, glass sphere iridescent, right version
ERSAW30NAW-GLIRI-L	W.30xH.45xD.29 cm	1x E27	4,0 kg	nickel aged warm finish, glass sphere iridescent, left version
ERSAW30NAW-GLIRI-R	W.30xH.45xD.29 cm	1x E27	4,0 kg	nickel aged warm finish, glass sphere iridescent, right version
ERSAW30GSF-GLIRI-L	W.30xH.45xD.29 cm	1x E27	4,0 kg	gold satin finish, glass sphere iridescent, left version
ERSAW30GSF-GLIRI-R	W.30xH.45xD.29 cm	1x E27	4,0 kg	gold satin finish, glass sphere iridescent, right version

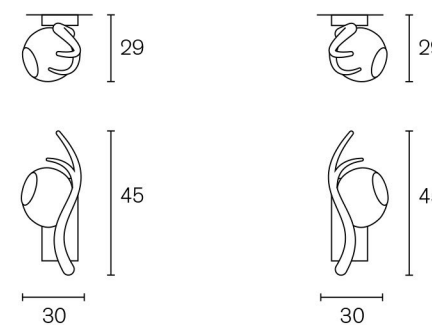

Left version

Right version

Standard the ERSA will be delivered with iridescent glass spheres. Other options are bronze translucent or clear glass spheres.
Wall lamps will be applied with a protective nano wax if ordered in brass burnished finish.

Specifications are subject to change without prior notice.

Art.nr.	Dimensions	Light bulb	Weight	Finish
ERSA1BLM-GLIRI	L.35xH.50x D.30 cm	1x E27	6,0 kg	black matt finish, glass sphere iridescent
ERSA1N-GLIRI	L.35xH.50x D.30 cm	1x E27	6,0 kg	nickel finish, glass sphere iridescent
ERSA1BR-GLIRI	L.35xH.50x D.30 cm	1x E27	6,0 kg	brass finish, glass sphere iridescent
ERSA1BRBUR-GLIRI	L.35xH.50x D.30 cm	1x E27	6,0 kg	brass burnished finish, glass sphere iridescent
ERSA1NAW-GLIRI	L.35xH.50x D.30 cm	1x E27	6,0 kg	nickel aged warm finish, glass sphere iridescent
ERSA1GSF-GLIRI	L.35xH.50x D.30 cm	1x E27	6,0 kg	gold satin finish, glass sphere iridescent
ERSA2BLM-GLIRI	L.60xH.60x D.55 cm	2x E27	8,0 kg	black matt finish, glass sphere iridescent
ERSA2N-GLIRI	L.60xH.60x D.55 cm	2x E27	8,0 kg	nickel finish, glass sphere iridescent
ERSA2BR-GLIRI	L.60xH.60x D.55 cm	2x E27	8,0 kg	brass finish, glass sphere iridescent
ERSA2BRBUR-GLIRI	L.60xH.60x D.55 cm	2x E27	8,0 kg	brass burnished finish, glass sphere iridescent
ERSA2NAW-GLIRI	L.60xH.60x D.55 cm	2x E27	8,0 kg	nickel aged warm finish, glass sphere iridescent
ERSA2GSF-GLIRI	L.60xH.60x D.55 cm	2x E27	8,0 kg	gold satin finish, glass sphere iridescent
ERSA3BLM-GLIRI	L.65xH.60x D.55 cm	3x E27	10,0 kg	black matt finish, glass sphere iridescent
ERSA3N-GLIRI	L.65xH.60x D.55 cm	3x E27	10,0 kg	nickel finish, glass sphere iridescent
ERSA3BR-GLIRI	L.65xH.60x D.55 cm	3x E27	10,0 kg	brass finish, glass sphere iridescent
ERSA3BRBUR-GLIRI	L.65xH.60x D.55 cm	3x E27	10,0 kg	brass burnished finish, glass sphere iridescent
ERSA3NAW-GLIRI	L.65xH.60x D.55 cm	3x E27	10,0 kg	nickel aged warm finish, glass sphere iridescent
ERSA3GSF-GLIRI	L.65xH.60x D.55 cm	3x E27	10,0 kg	gold satin finish, glass sphere iridescent

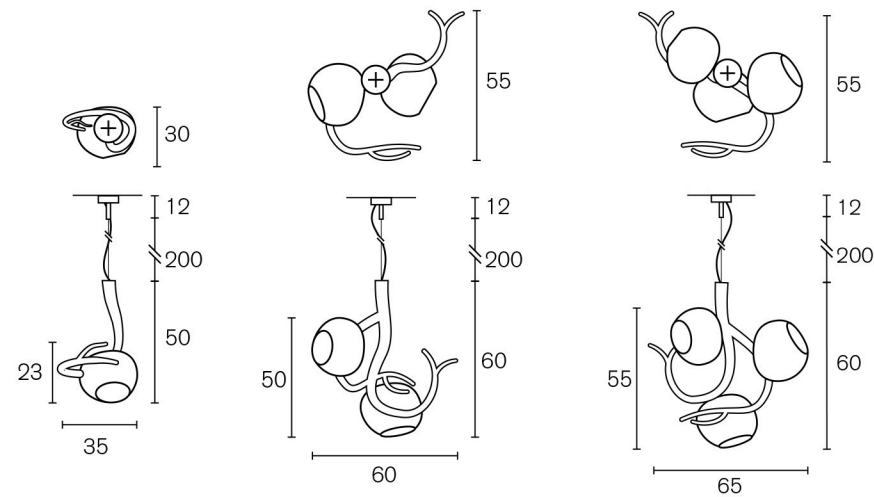

Standard the ERSA will be delivered with iridescent glass spheres. Other options are bronze translucent or clear glass spheres.
All elements are supplied with 2 meter steel cable, 2 meter electrical cable and a ceiling shade.

Specifications are subject to change without prior notice.

ERSAHL150NAW-GLIRI
Ersa Hanging Lamp Long with iridescent glass spheres (L.150xW.45xH.35 cm, nickel aged warm finish, 5 x E27, 15,0 kg)

Specifications are subject to change without prior notice.